

Operating Instructions

Find the model number and serial number on either the back or bottom of the unit. Please record them in the space below and retain this booklet as a permanent record of your purchase to aid in identification in case of theft.



MODEL NUMBER CQ-R121SEUC
SERIAL NUMBER _____
DATE PURCHASED _____
FROM _____

Panasonic®

Please read these instructions completely before operating this unit.

Panasonic welcomes you to our ever growing family of electronic product owners. We know that this product will bring you many hours of enjoyment. Our reputation is built on precise electronic and mechanical engineering, manufactured with carefully selected components and assembled by people who take pride in their work. Once you discover the quality, reliability, and value we have built into this product, you too will be proud to be a member of our family.

Use This Equipment Safely

When Driving

Keep the volume level low enough to be aware of road and traffic conditions.

When Car Washing

Do not expose the equipment, including the speakers and tapes, to water or excessive moisture. This could cause electrical shorts, fire, or other damage.

When Parked

Parking in direct sunlight can produce very high temperature inside your vehicle. Give the interior a chance to cool down before switching the unit on.

Use the Proper Power Supply

This equipment is designed to operate of a 12 volt, negative ground battery system (the normal system in a North American car.)

Protect the Tape Mechanism

Keep magnets, screwdrivers, or other metallic objects away from the tape mechanism and tape head to prevent poor performance or malfunctions.

Use Authorized Servicenters

Do not attempt to disassemble or adjust this precision equipment. Please refer to the Servicenter list included with this product for service assistance.

Specifications

GENERAL

Power Supply	: 12 V DC (11 V-16 V) Test Voltage 14.4 V, Negative ground
Maximum Power Output	: 30 W x 4 channels at 400 Hz, Volume Control maximum
Power Output	: 15 W per channel into 4 ohms, 40 to 30,000 Hz at 3 % THD.
Tone Action	: Bass; ± 12 dB at 100 Hz Treble; ± 12 dB at 10 kHz
Current Consumption	: Less than 2.5 A (tape mode, 0.5 W 4-speaker)
Speaker Impedance	: 4 Ω (4 - 8 Ω acceptable)
Dimensions (W×H×D)	: 7"×1-15/16"×5-7/8"(178×50×150 mm)
Weight	: 3 lbs.8 oz.(1.6 kg)

AM RADIO

Frequency Range	: 530-1,710 kHz
Useable Sensitivity	: 28 dB/ μ V(25 μ V/S/N 20 dB)

FM STEREO RADIO

Frequency Range	: 87.9-107.9 MHz
Useable Sensitivity	: 12 dBf. (1.1 μ V/75 Ω . S/N 30 dB)
50 dB Quieting Sensitivity	: 17 dBf (1.8 μ V/75 Ω)
Frequency Response	: 30-15,000 Hz ± 3 dB
Alternate Channel Selectivity	: 75 dB
Stereo Separation	: 35 dB at 1,000 Hz
Signal/Noise Ratio	: 70 dB (Mono)

TAPE PLAYER

Reproduction System	: 4-track, 2-program stereo
Tape Speed	: 1-7/8"/sec (4.76cm/sec)
FF/REW Time	: Less than 200 sec (C-60)
Frequency Response	: 35 - 14,000 Hz ± 3 dB
Wow and Flutter	: 0.12 % (WRMS)
Signal/Noise Ratio	: 52 dB

*Above specifications comply with EIA standards.

Note:

Specifications and design are subject to modification without notice due to improvements in technology.

Panasonic Consumer Electronics Company, Division of Matsushita Electric Corporation of America
One Panasonic Way, Secaucus,
New Jersey 07094

Panasonic Sales Company, Division of Matsushita Electric of Puerto Rico, Inc. ("PSC")
Ave.65 de Infanteria, Km.9.5
San Gabriel Industrial Park Carolina,
Puerto Rico 00985

Panasonic Canada Inc.
5770 Ambler Drive,
Mississauga, Ontario
L4W 2T3

YFM284C287ZA TAMACO01298-0 Printed in Taiwan

Power and Sound Controls

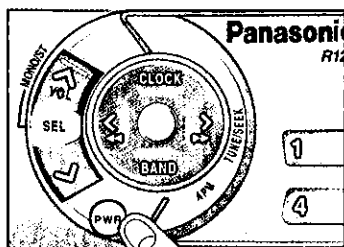
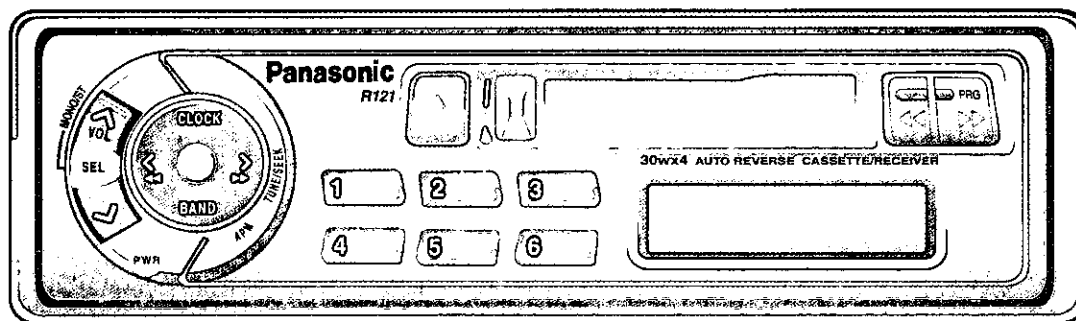

Power

If the car is not already running, Turn the key in the ignition until the accessory indicator lights.
Press PWR to switch on the power.

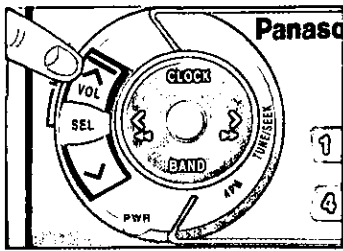

Volume

Press "VOL ^" or "VOL v" to increase or decrease volume.

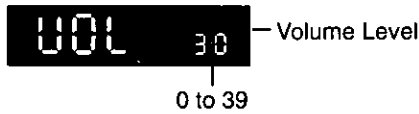

0 to 39

- Press "VOL ^" or "VOL v" for more than 0.5 second to change numeric levels on the display rapidly.

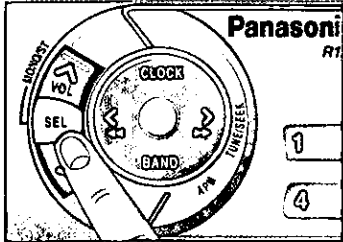

Changing Audio Modes

Press SEL to switch the audio mode as follows

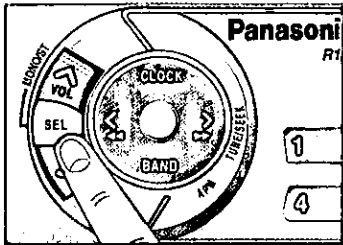

Bass and Treble

Press SEL to select the BASS (TREBLE) mode. Press "VOL ^" or "VOL v" to increase or decrease the bass/treble response.

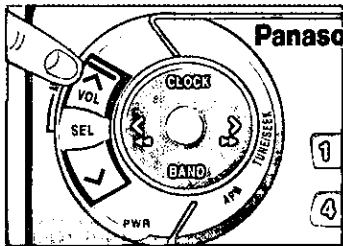

Balance

Press SEL to select the BALANCE mode. Press "VOL ^" or "VOL v" to shift the sound volume to the right or left speakers.

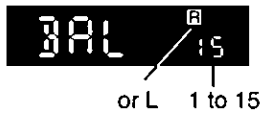

Fader

Press SEL to select the FADER mode. Press "VOL ^" or "v VOL" to shift the sound volume to the front or rear speakers.

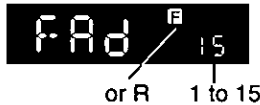

Note: when an audio mode (BAS/TRE/BAL/FAD) is selected but no operation is made with in 5 seconds (2 seconds at VOL mode), the display will return to the normal operation mode.
in such a case, press SEL again to select the control mode.

Radio Basics

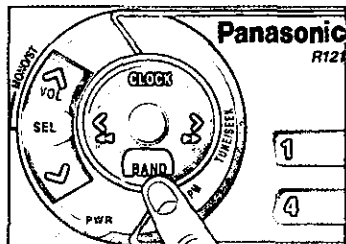
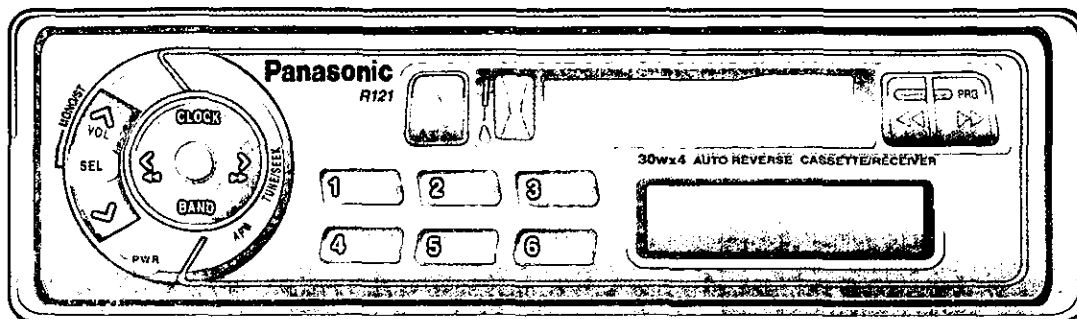

Selecting a Band

Press BAND to select the band as follows.

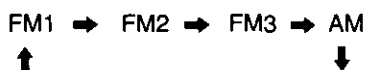

"ST" indicator lights if the station is broadcasting in stereo.

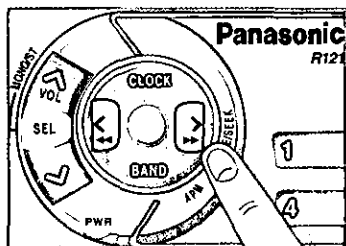

Manual Tuning

Press "< TUNE" or "TUNE >" to move to a higher or lower frequency.

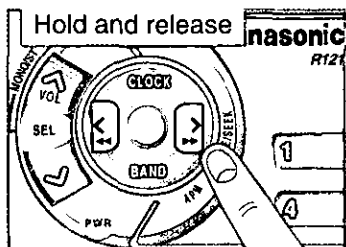

Hold and release

Seek Tuning

Press and hold "< TUNE" or "TUNE >" for more than 0.5 second, then release. The radio automatically stops on the next station.

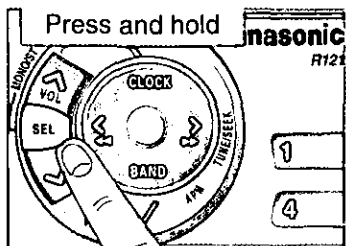

Press and hold

To reduce interference during FM broadcasts (MONO)

Press and hold SEL for more than 1 second for monaural reception in case a lot of interference is present in an FM stereo signal or to improve the listening quality of weak FM broadcasts. To turn it off press SEL for more than 1 second again.



Preset Station Setting

Up to 24 stations can be preset in the station memory as follows;

FM1	FM2	FM3	AM
6 stations	6 stations	6 stations	6 stations

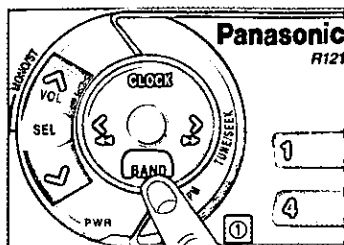

Manual Station Preset

- ① Press BAND to select a desired band.
 - ② Use manual or seek tuning to find a station that you want to program into memory.
 - ③ Press and hold one of the station selector buttons 1 through 6 until the display blinks. The memory is now set for that button on the band you have selected.
- Repeat the process to set other stations for the FM1 to AM bands



Note: You can change the memory setting by repeating the above procedure.

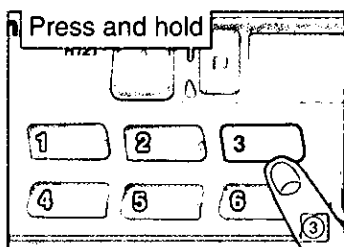
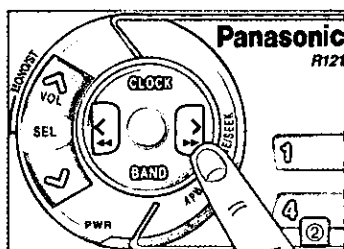

Tuning in a Preset Station

Press any of the buttons 1 through 6 to tune in the station preset by the above steps ① to ③.

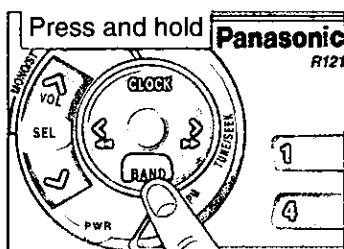

Auto Preset Memory

Select a band and press and hold BAND (APM) for more than 2 seconds.

- The 6 strongest available stations will be automatically set in memory on preset buttons 1 through 6.
- Once set, the preset stations are sequentially scanned for 5 seconds.

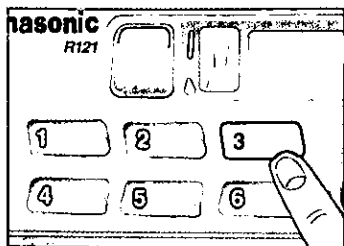

- Press the appropriate preset button for the station you want to hear.

CAUTION: For safety reasons, do not attempt to program while driving.

Cassette Tape Player Basics

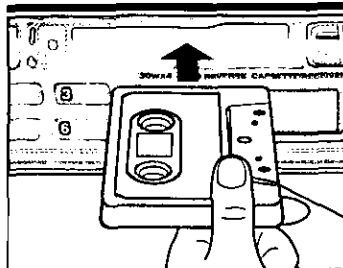
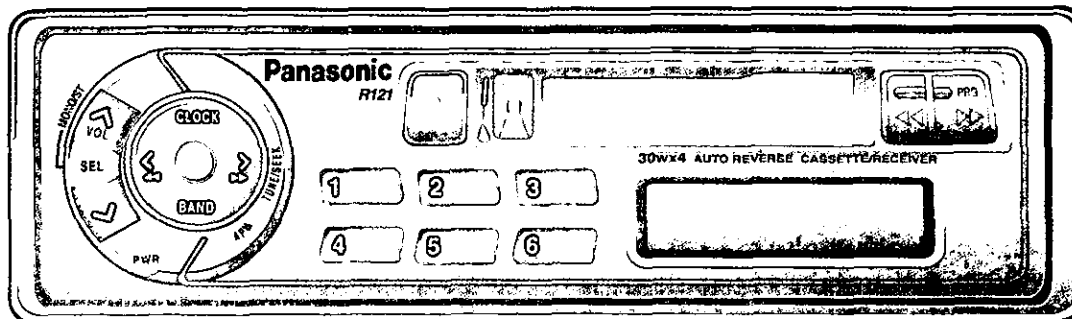

Loading a Cassette

Gently insert the cassette with the exposed tape facing to the right until the mechanism captures it, and playback starts.

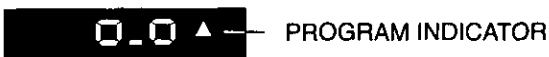

EXPOSED TAPE

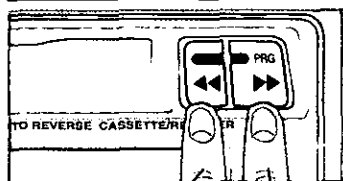

Rewind and Fast Forward

- When the program indicator (▲) light, press ◀ to rewind or press ▶ to fast forward the tape.
- When the program indicator (▼) light, press ◀ to fast forward or press ▶ to rewind the tape.



To stop rewind or fast forward, gently press the button that is not in use. The tape will resume playing from that position.

- “▲” light: REWIND
- “▼” light: FAST FORWARD
- “▲” light: FAST FORWARD
- “▼” light: REWIND

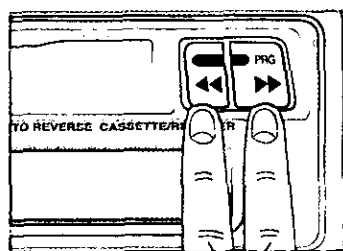

PRESS BOTH

Changing Sides

Firmly press ◀ (REW) and ▶ (FF) at the same time to switch to the program on the other side of the tape. The display changes to indicate which program is playing.



TOP SIDE PLAYING



BOTTOM SIDE PLAYING

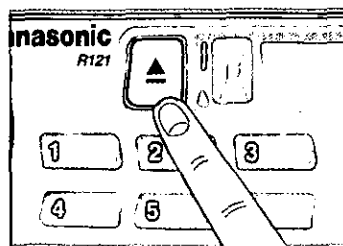

Stopping and Ejecting the Tape

Once inserted into the unit, your tape will play continuously until you eject it. If you press and engage ▲ (EJECT), the unit clears the tape and returns to radio operation. When you shut off the car engine, the tape will stop but not eject.

Note: Always remove the cassette when you are done using the cassette player. This will prolong the life of your tape.

CAUTION: To maintain your cassette player in top condition, avoid using tapes that are longer than 90 minutes (C-90).

Clock Basics (The clock system is 12-hours.)

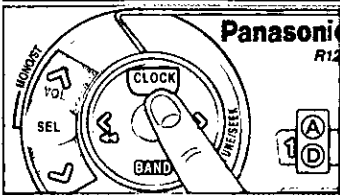
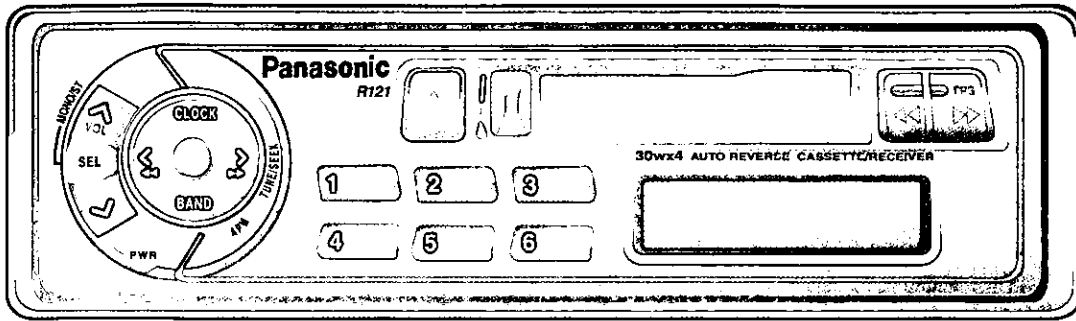

Initial Time Setting

Ⓐ Press CLOCK "Adj" is displayed..



Ⓑ Press and hold CLOCK again for more than 2 seconds. "12" blinks indicating the time setting mode is activated.



Ⓒ To set hours, press "< TUNE" or "TUNE >".



Ⓓ Press CLOCK again for minute setting.



Ⓔ To set minutes, press "< TUNE" or "TUNE >". Hold "<" or ">" to change numbers rapidly.



Ⓕ When you have set the time, press CLOCK

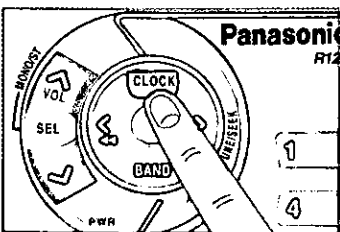
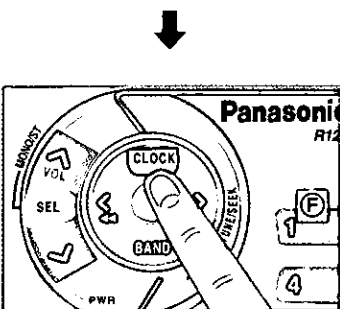
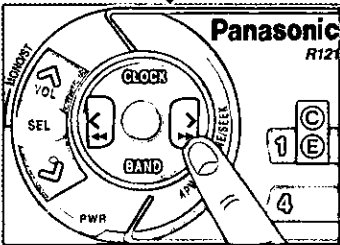
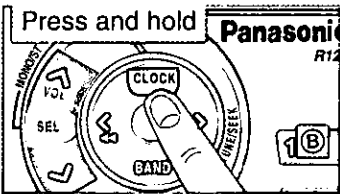

Resetting the Time

When you want to reset the time, press and hold CLOCK for more than 2 seconds to activate the time setting mode. Then, repeat step Ⓒ to Ⓕ above.

Selecting the Clock Display

Press CLOCK for clock display.

Press CLOCK once again, the current audio display mode resumes.

Installation Guide



WARNING

This installation information is designed for experienced installers and is not intended for non-technical individuals. It does not contain warnings or cautions of potential dangers in attempting to install this product.

Any attempt to install this product in a motor vehicle by anyone other than qualified installer could cause damage to the electrical system and could result in serious personal injury or death.

□ Overview

This equipment should be installed by a professional. However, if you plan to install this unit yourself, your first step is to decide where to install it. The instructions will guide you through the remaining steps: (Please refer to "WARNING" statement above).

- Identify and label the vehicle wires.
- Connect the vehicle wires to the wires of the power connector.
- Install the unit in the dash.
- Check the operation of the unit.

If you do encounter problems, please consult your nearest professional installer.

CAUTION: This unit will operate with a 12 volt DC negative ground auto battery system only. Do not attempt to use it in any other system. Doing so could cause serious damage.

Before you begin installation, look for the following items included in the packing with your unit:

- **Warranty Card**Fill this out promptly
- **Panasonic Servicenter for service Directory**Keep this for future reference in case the unit needs servicing
- **Installation Hardware**Needed for in-dash installation

□ Installation Hardware

No.	Item	Diagrama	Qty	No.	Item	Diagrama	Qty
①	Mounting Collar		1	⑤	Mounting Bolt (5mmø)		1
②	Hex Nut (5mmø)		1	⑥	Power Connector		1
③	Rear Support Strap		1	⑦	Dismounting Plate		1
④	Tapping Screw (5mmøx16mm)		1				

□ Required Tools

You'll need a screwdriver, a 1.5 volt AA battery, and the following:

12V DC
TEST BULB



ELECTRICAL
TAPE



SIDE-CUT
PLIERS



□ Dashboard Specifications

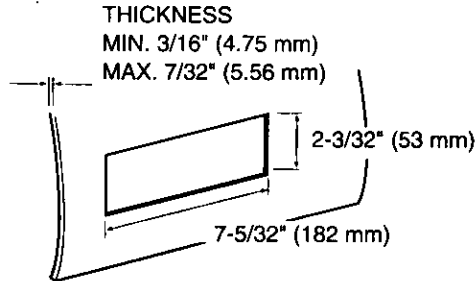

□ Identify All Leads

The first step in installation is to identify all the vehicle wires you'll use when hooking up your sound system.

As you identify each wire, we suggest that you label it using masking tape and a permanent marker. This will help avoid confusion when making connections later.

Note: Do not connect the power connector to the stereo unit until you have made all connections. If there are no plastic caps on the stereo hooking wires, insulate all exposed leads with electrical tape until you are ready to use them. Identify the leads in the following order.

Power Lead

If your vehicle has a radio or is pre-wired for one:

Cut the connector plug off (leaving the leads as long as possible) so that you can work with individual leads.

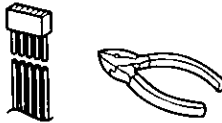

Turn the ignition on to the accessory position, and ground one lead of the test bulb to the chassis

Touch the other lead of the test bulb to each of the exposed wires from the cut radio connector plug. Touch one wire at a time until you find the outlet that causes the test bulb to light.

Now turn the ignition off and then on. If the bulb also turns off and on, that outlet is the vehicle power lead.

If your vehicle is not wired for an audio unit:

Go to the fuse block and find the fuse port for radio (RADIO), accessory (ACC), or ignition (IGN).

Battery Lead

If your stereo unit has a yellow lead, you will need to locate the vehicle's battery lead. Otherwise you may ignore this procedure. (The yellow battery lead provides continuous power to maintain a clock, memory storage, or other function.)

If your vehicle has a radio or is pre-wired for one:

With the ignition and headlights off, identify the vehicle's battery lead by grounding one lead of the test bulb to the chassis and checking the remaining exposed wires from the cut radio connector plug.

If your vehicle is not wired for an audio unit:

Go to the fuse block and find the fuse port for the battery, usually marked BAT.

Speakers*

Identify the vehicle speaker leads. There will be two leads for each speaker, usually color coded.

A handy way to identify the speaker leads and the speaker they connect with is to test the leads using a 1.5 volt AA battery as follows.

Hold one lead against one pole of the battery and stroke the other lead across the other pole. You will hear a scraping sound in a speaker if you are holding a speaker lead.

If not, keep testing different lead combinations until you have located all the speaker leads. When you label them, include the speaker location for each.

Antenna Motor

If your vehicle is equipped with an automatic power antenna, identify the vehicle motor antenna lead by connecting one bulb tester lead to the vehicle battery lead and touching the remaining exposed wires from the cut radio connector plug one at a time. You will hear the antenna motor activate when you touch the correct wire.

Antenna

The antenna lead is a thick, black wire with a metal plug at the end.

□ Connect All Leads

Now that you have identified all the wires in the vehicle, you're ready to begin connecting them to the stereo unit wires. The connection diagram on Electrical Connection shows the proper connections and color coding of the leads.

We strongly recommend that you test the unit before making a final installation.

You can set the unit on the floor and make temporary connections to test the unit. Use electrical tape to cover all exposed wires.

IMPORTANT : Connect the red power lead last, after you have made and insulated all other connections.

Ground

Connect the black ground lead of the power connector to the metal vehicle chassis.

Speakers

Connect the speaker wires. See the wiring diagram below for the proper hookups. Follow the diagram carefully to avoid damaging the speakers and the stereo unit.

The speaker used must be able to handle more than 30 watts of audio power. Speakers with low input ratings can be damaged.

Speaker impedance should measure 4-8 ohms, which is typically marked on most speakers. Lower or higher impedance speakers will affect output and can cause both speaker and stereo unit damage.

CAUTION: Never ground the speaker cords. For example, do not use a chassis ground system or a three-wire speaker common system. Each speaker must be connected separately using parallel insulated wires. If in doubt about how your car's speakers are wired, please consult with your nearest professional installer.

CORRECT
No Common Ground

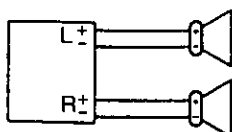

INCORRECT
Common Chassis Ground

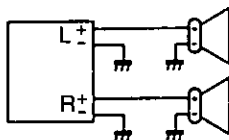

INCORRECT
Speaker Common
(common earth lead)

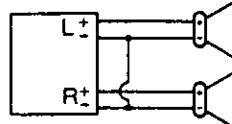

Motor Antenna

Connect the vehicle motor antenna lead to the blue motor antenna relay control lead.

Battery

Connect the yellow battery lead to the correct radio wire or to the battery fuse port on the fuse block.

Antenna

Connect the antenna by plugging the antenna lead into the antenna receptacle.

Power

Connect the red power lead to the correct vehicle radio wire or to the appropriate fuse port on the fuse block.

If the stereo unit functions properly with all these connections made, disconnect the wires and proceed to the final installation.

Final Installation

Lead Connections

Connect all wires, making sure that each connection is insulated and secure. Bundle all loose wires and fasten them with tape so they won't fall down later. Now insert the stereo unit into the mounting collar.

Congratulations! After making a few final checks, you're ready to enjoy your new auto stereo system.

Final Checks

1. Make sure that all wires are properly connected and insulated.
2. Make sure that the stereo unit is securely held in the mounting collar.
3. Turn on the ignition to check the unit for proper operation.

If you have difficulties, consult your nearest authorized professional installer for assistance .

Installation Procedures

1. Secure the Mounting Collar ①

Insert Mounting Collar ① into the Car's dashboard, and bend mounting tabs out with a screwdriver.

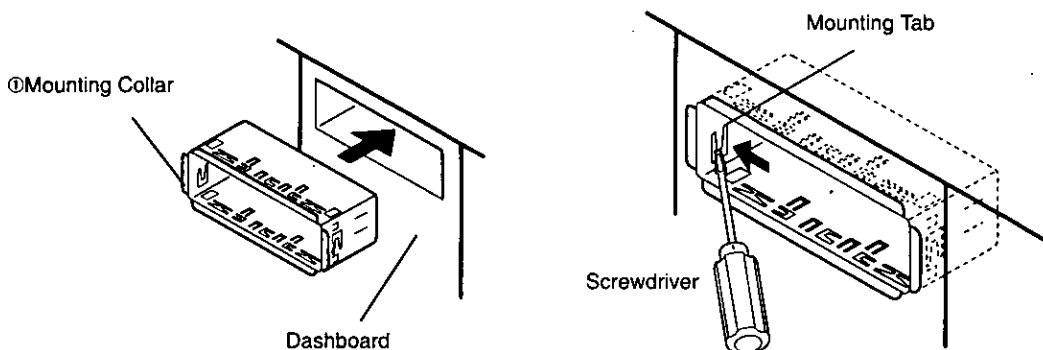

2. Secure the rear of the unit.

- Check the electrical connection by referring to this operating instructions.
- Connect the Mounting Bolt ⑤, using a suitable wrench.
- Insert the unit into Mounting Collar ① and push it in until "click" is heard.

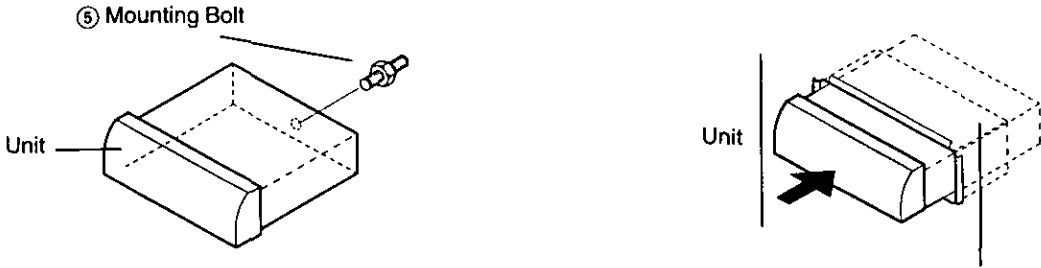

- Secure the rear of the unit to the car by either of the two recommended methods.

■ Using the Rear Support Strap ③

Affix one end of the Rear Support Strap ③ to the rear of the unit, and the other end to the Fire Wall of car, or some other metallic area.

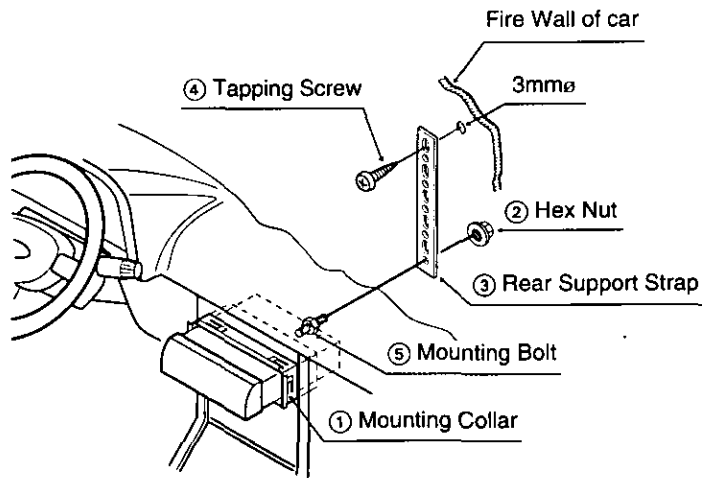

■ Using the Rubber Cushion (Optional)

(If there is an existing Rear Support Bracket on the Fire Wall of Car.)

Cover Mounting Bolt on the rear of the unit with Rubber Cushion (Optional), and mount it into the existing Rear Support Bracket.

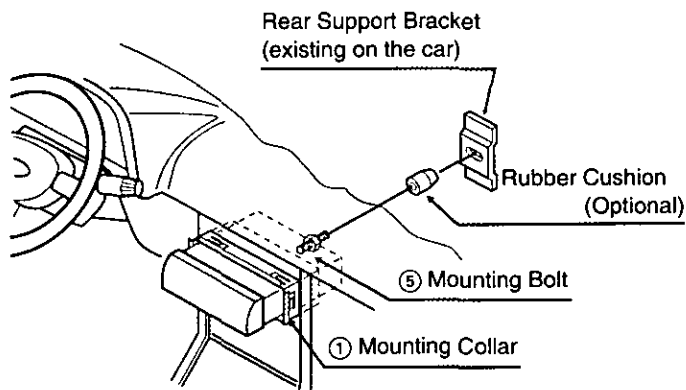

3. Plug the Power Connector ⑥.

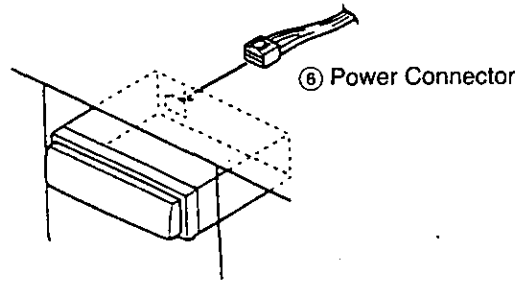

4. After installation, reconnect the negative (—) battery terminal.

To Remove the Unit

a) Remove the trim plate with a screwdriver

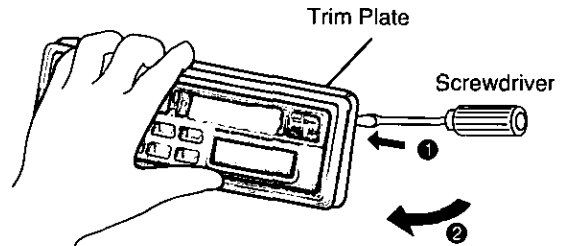

b) Pull out the unit while pushing two lock levers using Dismounting Plate ⑦ as follows.(Fig. 1, 2).

c) Remove the unit pulling with both hands.(Fig.3)

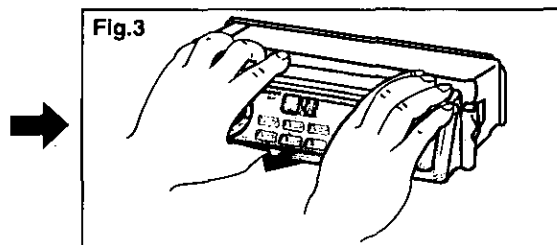
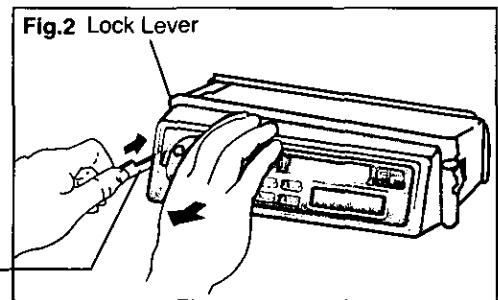
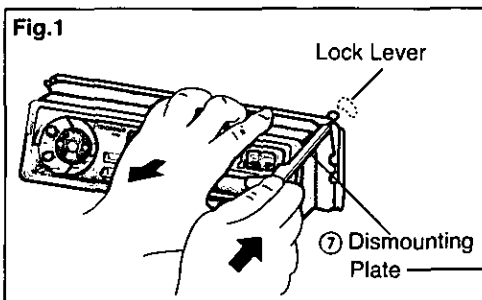

Note: Do not lose the Dismounting Plate. It will be needed to remove the unit from the unit from the car's dashboard.

Electrical Connection

Caution:

- To prevent damage to the unit, be sure to follow the connection diagram below.
- Remove the covering of the leads about 5 mm long from their end before connecting.
- Do not insert the power connector into the unit until the wiring is completed.
- Be sure to insulate any exposed wires from a possible short-circuit from the car chassis. Bundle all cables and keep cable terminals free from touching any metal parts.

CQ-R121SEUC

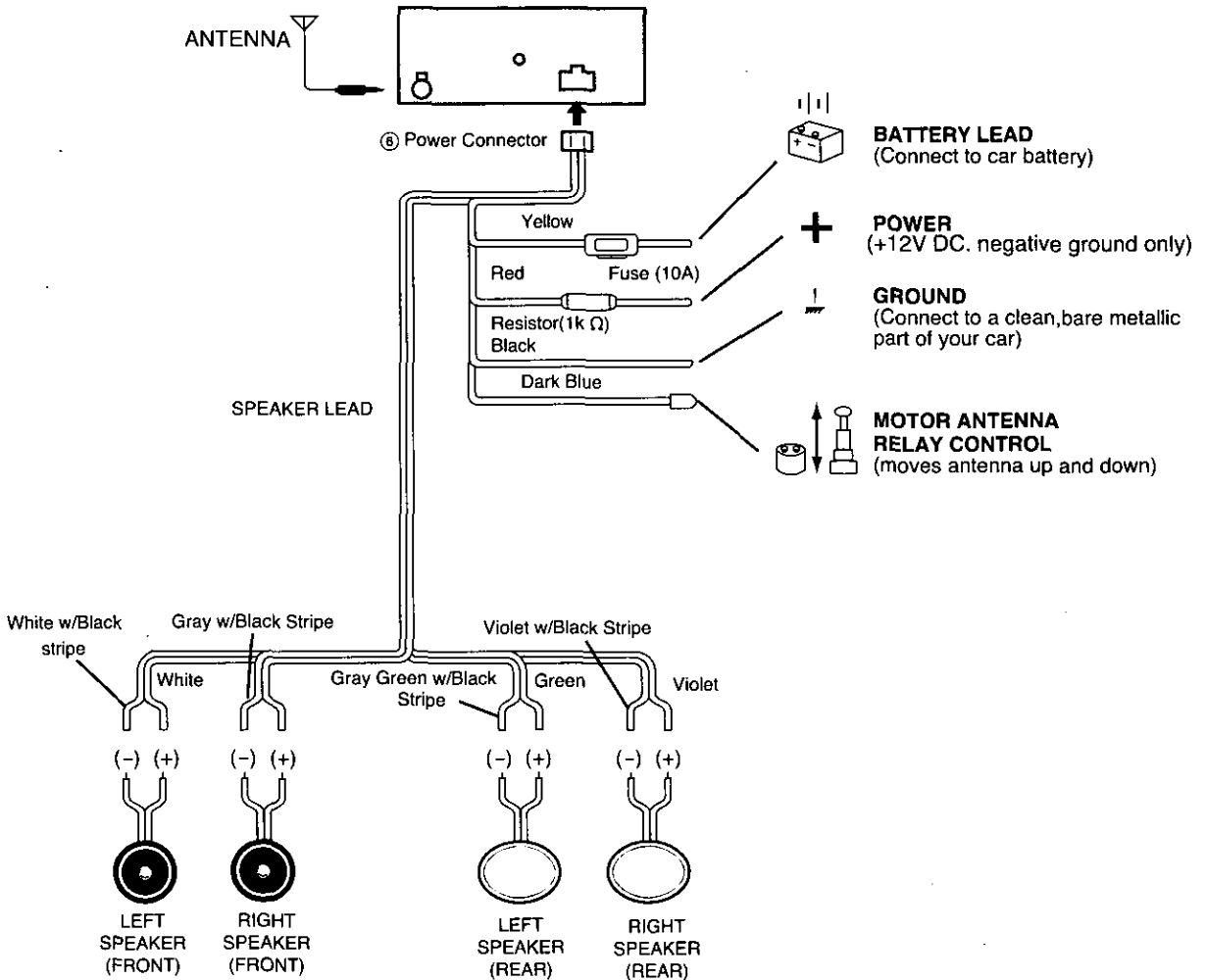

Troubleshooting

❑ Maintenance

Your product is designed and manufactured to ensure a minimum of maintenance. Use a soft cloth for routine exterior cleaning. Never use benzine, thinner, or other solvents.

❑ When Something Doesn't Work

Check Troubleshooting Tips for possible causes and solutions to any problem you might be experiencing. Some simple checks or minor adjustments may eliminate the problem.

❑ Product Servicing

If the suggestions in the charts don't solve the problem, we recommend that you take it to your nearest authorized Panasonic Servicenter. The unit should be serviced only by a qualified technician.

❑ Replacing the Fuse

Use fuses of the same specified rating (10amps). Using different substitutes or fuses with higher ratings, or connecting the unit directly without a fuse, could cause fire or damage to the stereo unit. If the replacement fuse fails, contact your nearest Panasonic Servicenter for service.

❑ Notes on Cassette Tapes

Tape Slack:

Use a pencil or similar object to take up the slack as shown. If a loose tape is used, this may result in the tape becoming tangled in the rotating parts of the unit.

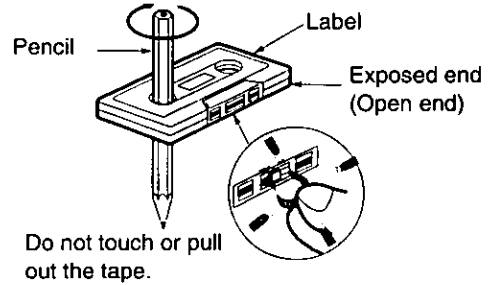

❑ Troubleshooting Tips

PROBLEM	POSSIBLE CAUSE	PROBABLE SOLUTION
Unit won't turn on.	Dead vehicle battery. Ignition not on. Bad power line connection Fuse burned out	Charge vehicle battery, Turn ignition to On or Accessory, Check connections. Replace fuse.
Radio has static.	Antenna not hooked up. Close to high power lines.	Hook up antenna. Move away from high power lines.
Radio memory buttons don't work.	Not holding buttons down long enough.	Press and hold buttons for more than 2 seconds.
Tape sound quality is poor.	Heads are dirty. Poor quality tape.	Clean heads. (Ask a service representative for advice.) Use better quality tape.
Tape Won't change programs.	Not pressing ►► (FF) and ◀◀ (REW) buttons at the same time.	Press ►► (FF) and ◀◀ (REW) buttons at the same time.